

TRIPLE•C

MULTI-BAND COMPRESSOR & ENVELOPE
SINGLE CHANNEL/STEREO CHANNEL VERSION



USER'S MANUAL

TABLE OF CONTENTS

INTRODUCTION

<i>Table of Contents</i>	3
<i>Introduction</i>	5
<i>Front Panel</i>	6
<i>Rear Panel</i>	8
<i>Signal Flow Diagram</i>	9
<i>TRIPLE•C Setups</i>	10

BASIC OPERATION

<i>The TRIPLE•C Display</i>	12
<i>I/O Setup</i>	13
<i>Recall</i>	15
<i>Edit</i>	15
<i>Store</i>	15

COMPRESSION MODES

<i>Full-range Mode</i>	16
<i>Multi-band Mode</i>	18
<i>Envelope Mode</i>	20
<i>Sidechain Operation</i>	22
<i>Using Compression - A Guide</i>	23

APPENDIX

<i>Important Safety Instructions</i>	26
<i>MIDI Implementation</i>	28
<i>MIDI Control Changes</i>	29
<i>Technical Specifications</i>	30
<i>Preset List</i>	31

INTRODUCTION

Congratulations on the purchase of your new TC Electronic TRIPLE•C Compressor

The TRIPLE•C is a highly flexible Compressor especially designed for single source processing but with a great variety of applications. Whether your main tasks are live production or in the recording studios we are confident the TRIPLE•C will cover your needs when it comes to compression. Three compression modes will comply the flexibility needed when working with different program material such as vocals, drums, bass, guitar etc.

- **The Multi-band mode** allows compression and spectral balancing of three independent bands on any single source without getting into the usual problems of pumping and breathing.
- **The Full-range mode**, offers standard compression utilizing the feed forward principle known from various analog Compressors. The TRIPLE•C simulates the best from analog Compressors and provides top quality Full-band compression instantaneously.
- **The Envelope mode** allows changing the dynamic content of the incoming source material in its entire duration. This can be used for various kinds of dynamic shaping e.g. for extending the sustain source or adding more “click” to percussive material such as a bass drum. The Envelope mode will also apply in many Dance/DJ and more experimental types of music as a powerful tool of expression.
- **The Sidechain function** allows an external source to either fully control or contribute to the control of the compression performed by the TRIPLE•C.
- **The TRIPLE•C Stereo version** can perform either as a two stereo Compressor or as a TRIPLE•C Single version with Sidechain option.

Additionally the TRIPLE•C features all the best from the digital world such as factory and user presets, remote controllability via MIDI and Digital I/O.

This manual covers both the **TRIPLE•C Single Channel** version as well as the **TRIPLE•C Stereo Channel** version.

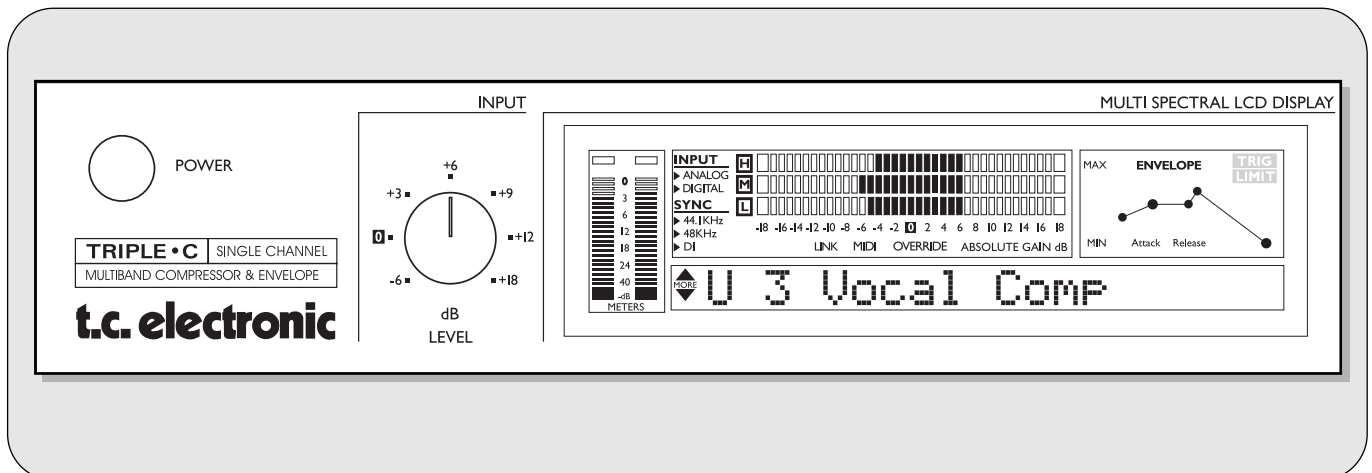

FRONT PANEL

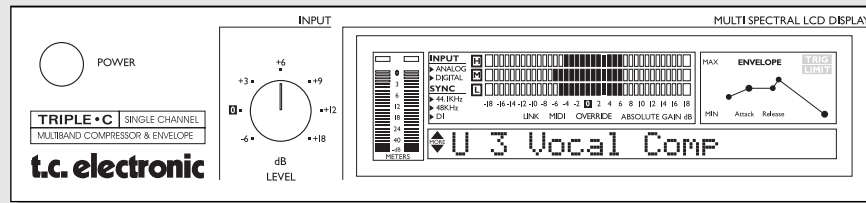

POWER key

On/Off switch for the unit.

INPUT LEVEL knob

Adjusts the Input level.
Range is -6dB to +18dB.

INPUT/OUTPUT meters

Peak meter showing Input and Output level. The meter range is: 0, -3, -6, -12, -18, -24, -40dB. For the Stereo version this meter is common for both channels.

INPUT OVERLOAD LED

The OVERLOAD LED indicates one of two situations: The Input level is too hot and therefore overloading or there is an internal DSP overflow. The OVERLOAD LED is lit when 1 sample is @ 0dBFS.

OUTPUT OVERLOAD LED

Indicates that the Output is too hot. This will occur if e.g. too much gain has been added through the TRIPLE•C. The OVERLOAD LED is lit when 1 sample is @ 0dBFS.

INPUT - Analog/Digital

Indicates whether the TRIPLE•C is set to analog or digital Input. When set to digital Input, the Sample Rate automatically switches to DI. In case of no or unacceptable clock the "Digital" and "DI" icon will be blinking.

SYNC

Indicates the current clock of the TRIPLE•C. When locked to an external clock, the "DI" icon is lit and the incoming Sample Rate is displayed by either the 44.1 or 48 icon.

If no or unacceptable clock is available, the "Digital" and "DI" icons will be blinking.

LINK indicator

Indicates that the unit is linked to a second TRIPLE•C.

MIDI

When MIDI information is received the MIDI icon will blink.

Gain Metering

The Gain meter indicates the total gain through the TRIPLE•C and simultaneously shows the gain reduction.

Envelope Section

Indicates the setting of the Envelope Mode. Please see Envelope chapter in the manual for further information.

TRIG

Indicates when the Envelope function is processing the incoming signal.

LIMIT

When the LIMIT LED is lit the Envelope Softclipper is active.

MULTI-BAND OFF key

Turns the Multi-band mode on/off i.e. activates the full band mode. When the LED is lit the Multi-band algo is inactive.

PEAK SENSITIVE key

The TRIPLE•C is basically an RMS based Compressor, meaning that it responds to average level of the incoming source material. This key turns the TRIPLE•C into a Peak based Compressor. When the LED is lit the TRIPLE•C is in Peak mode. This feature is only available in Multi-band mode.

SOFTLIM key

Activates/deactivates the Soft-Limiter in the Output section. When the LED is lit, the Soft-Limiter is active.

FRONT PANEL

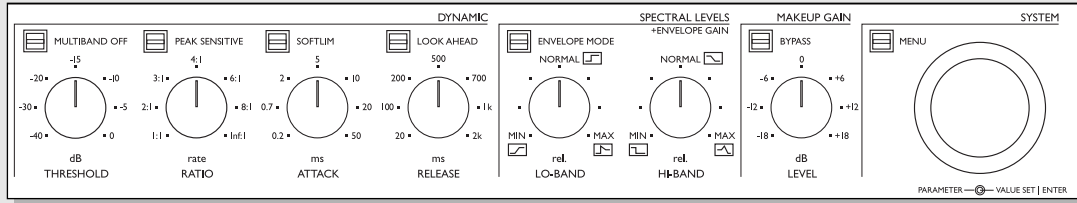

LOOK AHEAD key

When in Multi-band mode the Look Ahead delay (3ms) can be activated allowing even more precise processing.

THRESHOLD knob

Multi-band mode: Sets the Mid band Threshold value. The Lo/Hi bands are slaved accordingly.

Full-range mode: Sets the Threshold value.

Envelope mode: Sets the Threshold of the Envelope.

RATIO knob

Multi-band mode: Sets the Mid band Ratio value. The Lo/Hi bands are slaved accordingly.

Full-range mode: Sets the compression Ratio.

Envelope mode: No function.

ATTACK knob

Multi-band mode: Sets the Mid band Attack value. The Lo/Hi bands are slaved accordingly.

Full-range mode: Sets the Attack time.

Envelope mode: Sets the Attack time of the gain added to the start-up of the source.

RELEASE knob

Multi-band mode: Sets the Mid band Release time. The Lo/Hi bands are slaved accordingly.

Full-range mode: Sets the Release time.

Envelope mode: Sets the Release time of the gain added to the ring-out of the source.

ENVELOPE MODE key

Activates/deactivates the Envelope mode.

LO-BAND knob

Multi-band mode:

Adjusts the Output level of the processed Lo-Frequency band.

Full-range mode: No function

Envelope mode: Attack Gain.

HI-BAND knob

Multi-band mode:

Adjusts the Output level of the processed Hi-Frequency band.

Full-range mode: No function

Envelope mode: Release Gain.

BYPASS key

Bypasses all processing parameters but not the System settings found in the I/O menu. When the key LED is lit the TRIPLE•C is bypassed.

LEVEL knob

Sets the overall Make Up gain through the TRIPLE•C. This is used to compensate for gain loss in the Compressor. The absolute gain through the TRIPLE•C is displayed in the LCD by the fixed LED in the gain meter. Range: +/- 18dB.

MENU key

Push MENU and use the VALUE SET wheel to select menu.

PARAMETER wheel

Scrolls between parameters.

VALUE SET/ENTER wheel

Is used to change values.

When pushed, actions such as Recall, Store etc. are approved.

REAR PANEL

Single Version

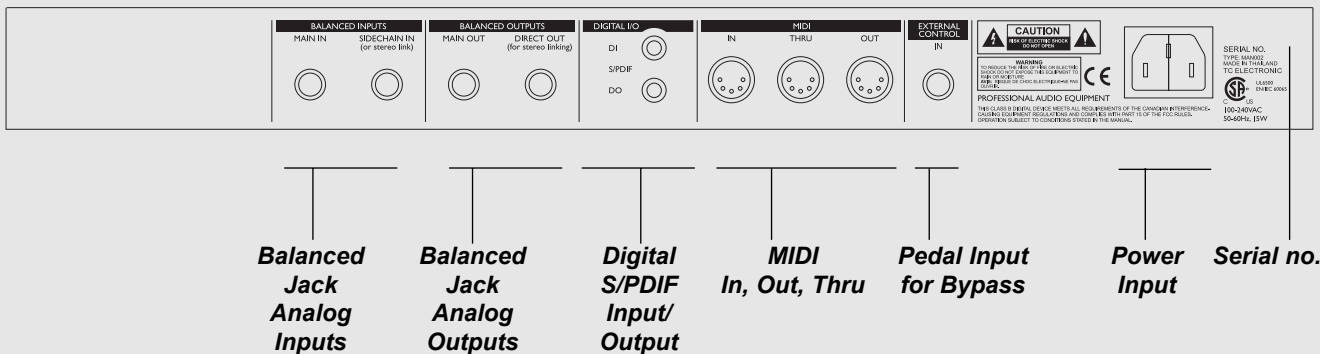

Stereo Version

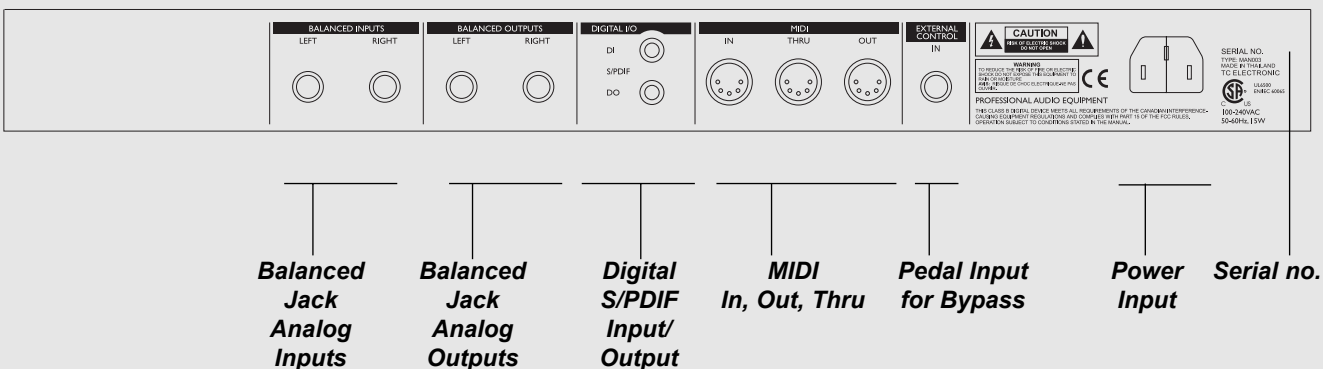

MIDI Cable

DIN CONNECTOR
5POLE - MALE
45 degrees

DIN CONNECTOR
5POLE - MALE
45 degrees

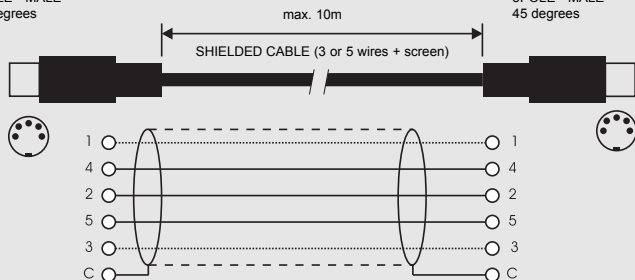

Jack (unbalanced) - XLR

Sleeve - Pin 1 (Ground)
Tip - Pin 2 (Hot)
Sleeve - Pin 3 (Cold)

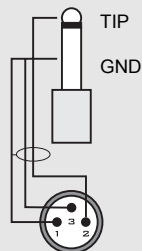

Jack (balanced) - XLR

Sleeve - Pin 1 (Ground)
Tip - Pin 2 (Hot)
Ring - Pin 3 (Cold)

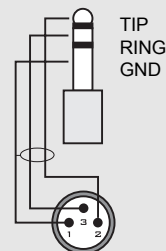

SIGNAL FLOW

TRIPLE•C Single Channel Version

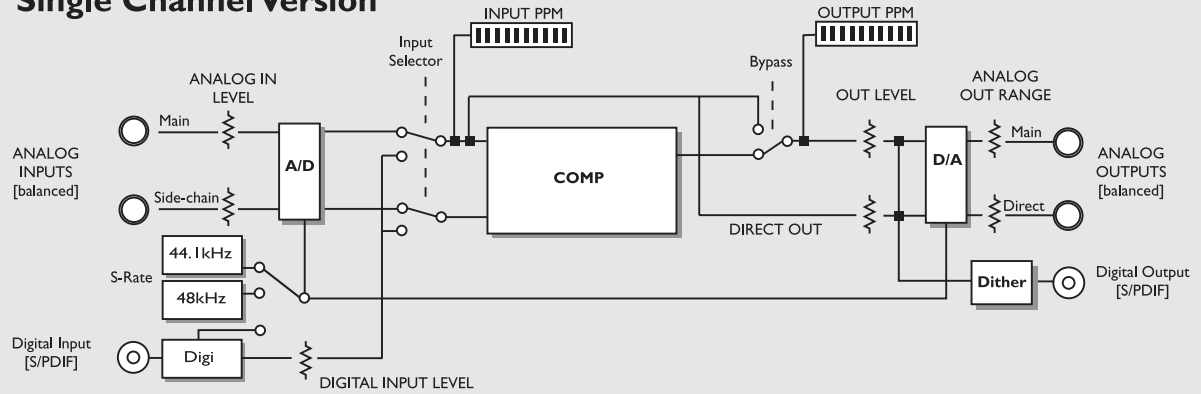

TRIPLE•C Stereo Channel Version

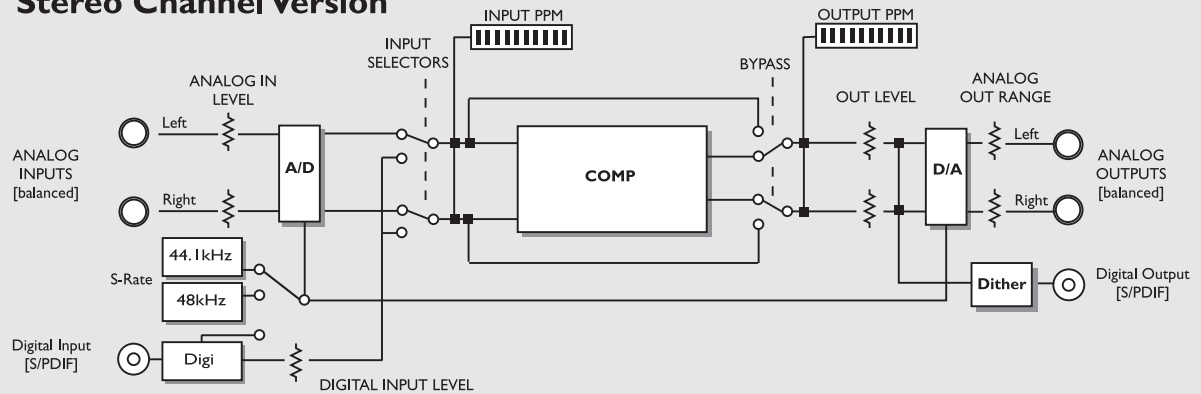

TRIPLE•C - SETUPS

Setting up the TRIPLE•C

The TRIPLE•C is a very flexible unit and may be used in numerous different setups. Here are illustrations and explanations of some of the most common setups.

Channel Insert

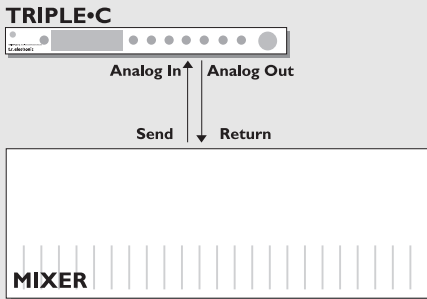

TRIPLE•C in a Single Channel Insert

- Use the send/return connections on a single channel on your analog mixer.
- Use the analog Input/Outputs on the TRIPLE•C.
- Set the TRIPLE•C Inputs to analog.

Digital Insert

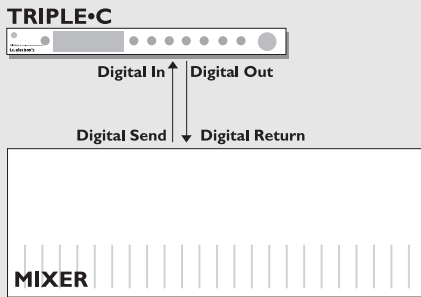

TRIPLE•C in a Digital Insert

- Connect the TRIPLE•C's digital In/Out to a digital Send/Return on your mixer.
- Use the TRIPLE•C as master clock by setting the Clock parameter in the I/O menu to 44.1kHz or 48kHz and the connected device/mixer to External.

Group Insert

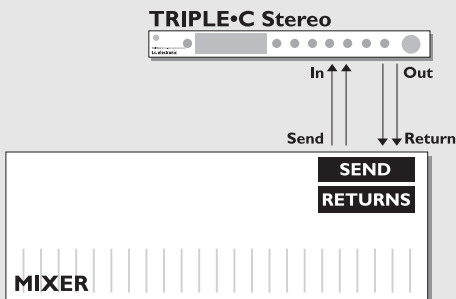

TRIPLE•C Stereo version in a Group Insert

- Connect the TRIPLE•C Stereo in a group-insert on your mixer.
- With this setup you are able to use compression on e.g. an entire drum-set or on backing vocals.



Please note that if you route one or more channels on your mixer to both the Master Out and to a subgroup where a digital Compressor is inserted, you can experience an unwanted comb-filtering effect.

TRIPLE•C - SETUPS

Setting up the TRIPLE•C

EQ Insert

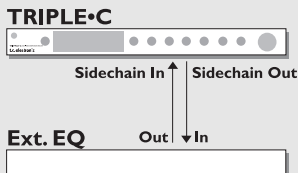

EQ Insert in the TRIPLE•C Sidechain

- Connect the TRIPLE•C Direct Out to the Input of the EQ and the EQ Output to the TRIPLE•C Input.
- Set Sidechain to “On”.
- The source signal passing the TRIPLE•C will not be directly influenced by the connected EQ unit, however the EQ will allow you to pinpoint the key frequencies that you want the Compressor to respond to.

Side-chain “On/Add”

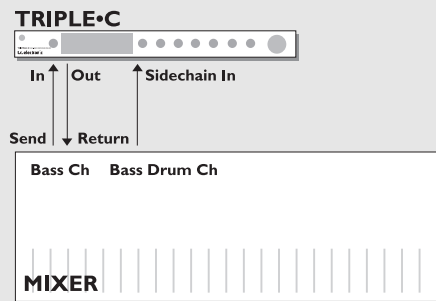

Side Chain “On”

- Use the send/return connections on a single channel on your mixer.
- Connect the Output of the channel you wish to contribute to (Add) or control (On) the compression.
- Press MENU, select Ext Side using the PARAMETER wheel and select “Add” or “On” using the VALUE SET wheel.

In the illustrated example the Bass drum channel will either contribute to, or control the compression applied on the Bass channel.

Two Triple•C's connected as one Stereo unit

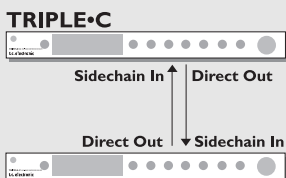

Stereo Setup Using two TRIPLE•C Single Channels

- Connect two TRIPLE•C Single Channel units as illustrated.
- On both units:
Press MENU, select “I/O Menu” using the VALUE SET wheel. Press ENTER, select “Link” using the PARAMETER wheel and set the Link parameter to “On.”
- Connect MIDI Out from the unit you wish to be “master” to MIDI In on unit you want to operate as “slave”.
- The units now operate as one stereo unit.
All parameter adjustments performed on the “master” are now instantaneously copied to the “slave” unit.

THE TRIPLE•C DISPLAY

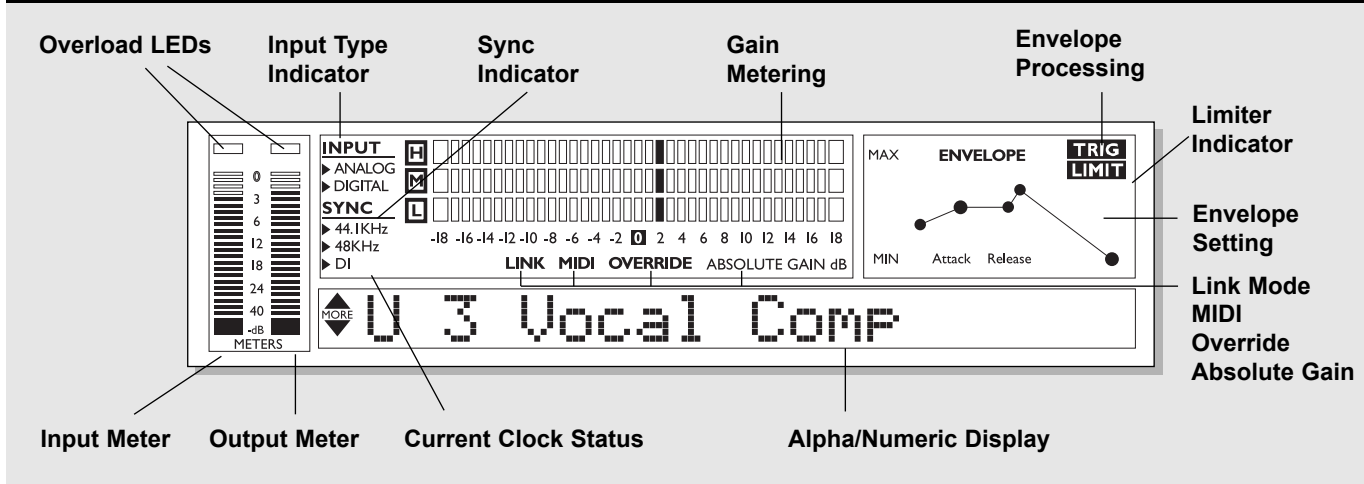

Input/Output meters

Peak meter showing Input and Output level. The Meter range is: 0, -3, -6, -12, -18, -24, -40dB.

Input Overload LED

The OVERLOAD LED indicates one of two situations: The Input level is too hot and therefore overloading or there is an internal DSP overflow. The Overload LED is lit when 1 sample is @ 0dBFS.

Output Overload LED

Indicates when the Output is too hot. This will occur if e.g. too much gain has been added through the TRIPLE•C. The Overload LED is lit when 1 sample is @ 0dBFS.

Input - Analog/Digital

Indicates whether the TRIPLE•C is set to analog or digital Input. When set to digital Input, the Sample Rate automatically switches to DI. In case of no or unacceptable clock the "Digital" and "DI" icon will be blinking.

Sync

Indicates the current clock of the TRIPLE•C. When locked to an external clock, the "DI" icon is lit and the incoming Sample Rate is displayed by either the 44.1 or 48 icon. If no or unacceptable clock is available, the "Digital" and "DI" icons will be blinking.

Link indicator

Indicates that the unit is linked to a second TRIPLE•C.

MIDI

When MIDI information is received the MIDI icon will blink.

Gain Metering

The Gain meter indicates the total gain through the TRIPLE•C and simultaneously shows the applied gain reduction.

Envelope Setting

Indicates the setting of the Envelope Mode. Please see Envelope chapter for further information.

Trig

Indicates when the Envelope function is processing the incoming signal.

Limit

When the LIMIT LED is lit the Softclipper is active.

Override

When recalling a preset it is most likely that eg. Threshold, Ratio, Attack and Release settings do not match the positions of the corresponding knobs on the front. When turning one of these knobs the current value is displayed in the display and the OVERRIDE LED will blink until you pass the "knob-position" that matches the actual parameter setting. When this "match-point" is passed the parameter can be adjusted.

I/O SETUP

I/O Setup

In the I/O menu you will find all system related parameters such as Input/Output settings, analog/digital, Status Bit, Dither and various MIDI settings. For successful operation of the TRIPLE•C these parameters must be correctly set !

To access the I/O menu

- Press MENU.
- Select I/O Menu using the VALUE SET wheel.
- Press ENTER to enter I/O Menu.

In the I/O Menu you select parameters using the PARAMETER wheel and you change values using the VALUE SET wheel.

Input

Select between Analog or Digital.

Analog Input

When "Analog" is selected the TRIPLE•C automatically defaults to the internal 44.1kHz clock as Sample Rate.

Digital Input

When "Digital" is selected the TRIPLE•C attempts to lock to the S/PDIF Input. During the lock-up period the "DI" display icon blinks indicating none or unacceptable clock, and the Outputs are muted. When lock is achieved the "DI" icon turns solid, and the Outputs are un-muted.

Clock

Analog Input

When Input source is analog the following Sample Rates are available:

- Internal 44.1kHz - The TRIPLE•C runs at internal 44.1kHz.
- Internal 48kHz - The TRIPLE•C runs at internal 48kHz.
- Digital - The TRIPLE•C locks to the incoming digital clock.

Digital Input

When Input Source is digital the following Sample Rates are available:

- Internal 44.1kHz - The TRIPLE•C runs at internal 44.1kHz.
- Internal 48kHz - The TRIPLE•C runs at internal 48kHz.
- Digital - The TRIPLE•C locks to the incoming digital clock.



Please note that when using internal clock with external digital audio, the incoming digital audio must be in sync with the TRIPLE•C internal clock in order to avoid slip-samples.

****Rate Mismatch****

This Error message will occur in the display if the TRIPLE•C detects slip-samples. Typically this problem only occurs in special clock setups e.g. if the TRIPLE•C is running via internal clock, while processing audio from the Digital Input. If the incoming clock and the internal clock does not match the TRIPLE•C will display the above written error message.

Out Range

Range: 2dBu, 8dBu, 14dBu and 20dBu.

Sets the maximum gain range of the analog Output stage.

Analog Out Level

Adjusts the analog Output level. Range: 0 to -100dB

Digital In Gain

Adjusts the Digital In level. This parameter is only active when Digital In is selected.

Dither

Going from one type of bit resolution to a lower, e.g. from 24 bit to 16 bit, you actually lose 8 bits of information. The process of cutting off bits is called truncation and it introduces digital distortion of low level signals, due to the lack of complete signal information. To compensate for this, dither must be applied. Dither is a small amount of filtered noise that generates randomization at the noise floor, thereby ensuring a less distorted low level signal. Dithering is relevant only on digital Outputs and it is always the receiving device that determines the number of bits you must dither to. A CDR or a DAT recorder should normally be dithered to 16 bit.

Status Bits

Sets whether the TRIPLE•C is sending out AES/EBU (professional standard) or S/PDIF (consumer standard) status bits.

MIDI Channel

Range: Off/1-16/Omni.

Sets the responding MIDI channel of the TRIPLE•C.

I/O SETUP

MIDI CC

Range: On/Off.

Determines whether the TRIPLE•C should respond to MIDI Continuous Controllers or not. On page 29 you will find a list of the TRIPLE•C Continuous Controllers.

Program bank

Determines which bank an external MIDI device will address in the TRIPLE•C when sending a program change.

The options are: Factory, User or External.

When External is selected controller #32 can be used to address either the Factory or the User bank.

Factory bank: Controller #32=0

User bank: Controller #32=1

Bulk Dump

Press ENTER to perform a total Bulk dump of all presets to an external MIDI device such as a MIDI sequencer.

The TRIPLE•C is always ready to receive MIDI Bulk dump information.

SysEx ID

Determines the Sys-Ex ID number of the unit. All effects parameters; also changes and routings can be changed through MIDI Sys-Ex via an external MIDI device. In order to define which unit the sent MIDI Sys-Ex information should reach, the appropriate ID number must be set.

Link

Range:On/Off

Will link parameters between two Single Channel units when connected and used either in a Stereo Setup or in a Dual Mono setup.

Please see page 22 for further explanation.

View Angle

Adjusts the LCD display backlight for better viewing comfort.

RECALL - EDIT - STORE

Presets in general

The TRIPLE•C holds 50 factory presets (ROM bank) and you are able store 100 additional user presets in the RAM bank. When scrolling through the presets you will locate the user presets after the 50 factory presets.

Recall

To recall a preset:

- Press MENU.
- Dial the VALUE SET wheel until the display reads "Recall".
- Press ENTER.
- Use any wheel to scroll through the 50 Factory and 100 User presets. Until you have actually recalled a preset you are previewing. While previewing the preset name and number is blinking.
- Press ENTER to recall a preset.
The TRIPLE•C prompts "Recalled" for approximately one second and returns preset-name display.

Edit

To edit preset parameters:

- Press MENU.
- Select "Edit Menu" using the VALUE SET wheel.
- Press ENTER.
- Select parameter using the PARAMETER wheel and change values using the VALUE wheel.

Store

To store a preset with the same name:

- Press MENU.
- Turn the VALUE SET wheel until the display reads "Store".
- Press ENTER.
- The TRIPLE•C suggests the first available RAM space as storing location but you can select any of the 100 locations using the VALUE SET wheel.
- Press ENTER twice to store.

To rename a preset while storing:

- Press MENU.
- Dial the VALUE SET wheel to until the display reads "Store".
- Press ENTER.
- Select storing space using the VALUE SET wheel.
- For altering the preset name; use the PARAMETER wheel to move cursor and the VALUE SET wheel to select character.
- Press ENTER twice to store the preset with the new name.

FULL-RANGE MODE

Full-range mode is the mode typically found in standard Compressors. Threshold, Ratio, Attack and Release settings apply for the entire frequency area.

To select the Full-range Mode

- ENVELOPE MODE key LED must be off/unlit.
- MULTI-BAND OFF LED must be lit.

Input Section

Input Level

Adjusts the Input level of the TRIPLE•C. Play your source material through the TRIPLE•C and observe the Input meters in the display. Correct operation level is approx -6 to -3dBs with an occasional peak at 0dB. If the Input signal at any time overloads, - reduce the Input level.

Dynamic Section

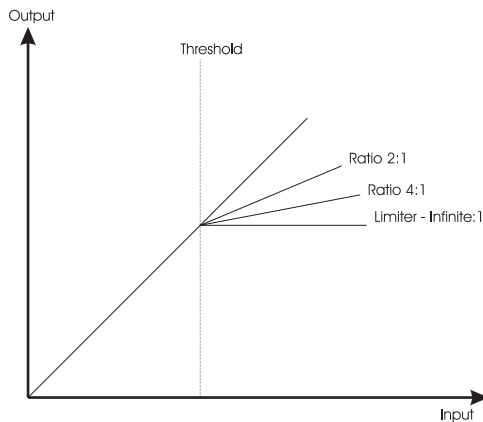

Threshold

When the signal is above the set Threshold point the Compressor is activated and the gain of any signal above the Threshold point is processed according to the Ratio, Attack and Release settings.

Ratio

The Ratio setting determines how hard the signal is compressed. (see illustration above).

Example: With a Ratio setting of 2:1 an Input signal at 4dB above Threshold is reduced to only 2dB on the Output-side.

Attack

The Attack time is the response time of the Compressor. The shorter Attack time the sooner the Compressor will reach the specified Ratio after the signal rises above the Threshold point.

Release

The Release time is the time it takes for the Compressor to release the gain reduction of the signal after the signal drops below the Threshold point again.

Softlim

Softlimiter on/off switch. Where the Compressor mostly is used to gradually reduce the dynamic content above the set Threshold point a limiter is used to directly avoid hitting the upper limit of 0dBFS. Compressors and limiters are often used in conjunction. - The Compressor as the musical/gentle way of reducing the level and the limiter as a hard abrupt control to avoid distortion. See illustration.



In Full-range mode the controls in the Spectral adjust section have no effect.

Look Ahead

The Look Ahead delay function is not available in the Full-range mode

Makeup Gain Section

Bypass

Press to bypass the TRIPLE•C. All processing parameters are bypassed. Input Level control and all System settings found in the I/O menu are not bypassed.

Level

When a signal is compressed, the maximum Output level of the signal is reduced. Since it is a reduction in dynamic content and not a gain-reduction that is the object of applying compression a make-up gain is necessary to lift the signal to appropriate level. Observe the gain reduction via the meters and lift the processed signal to approximately 0dB using the Level knob in the Make Up Gain section. For detailed information please read the section on make up gain in the section called "Using Compression".

FULL-RANGE MODE

Edit Menu

To enter the Edit menu

- Press **MENU**.
- Use the **VALUE SET** wheel to select the Edit menu and press **ENTER**.

DRG - Digital Radiance Generator

Range: 1-10

With this parameter you can add second harmonic distortion. This is a commonly used tube-simulation that will add warmth to the signal.

External Sidechain

Range: Off, On, Add

Determines how the TRIPLE•C should respond to the signal present on the External Sidechain.

- Off : This is the "Normal" setting. The TRIPLE•C will only respond to the Input signal and not to any signal present on the Sidechain.
- On : The compression will be controlled only by the signal present on the Sidechain Input.
- Add : In this mode the TRIPLE•C will respond both to the Input signal and to the signal present on the Sidechain. The Input signal and the Sidechain signal are added for compression control. Please note that the signal present on the Sidechain Input under no circumstances is passed to the Outputs. The Sidechain Input is only for compression control.



Hi X-Over, Lo X-Over and Comp Style parameters are ineffective in the Full Range mode.

MULTI-BAND MODE

Multi-band mode - is a 3 band compression mode. By dividing the source material into 3 frequency areas you can avoid that peaks at certain frequencies controls the compression of the entire signal. By setting the Lo and Hi Cross-over frequencies you determine the range of the Frequency areas.

To select Multi-band mode

- ENVELOPE MODE key LED must be off/unlit.
- MULTI-BAND OFF LED must be unlit.

Input Section

Input Level

Adjusts the Input level of the TRIPLE•C. Play your source material through the TRIPLE•C and observe the Input meters in the display. Correct operation level is approx -6 to -3dB with an occasional peak at 0dB. If the the Input signal at any time overloads - reduce the Input level.

Dynamic Section

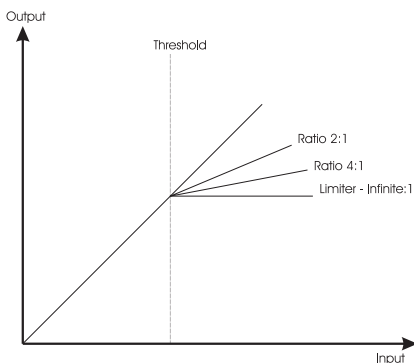

Threshold

When the signal is above the set Threshold point the Compressor is activated and the gain of any signal above the Threshold point is processed according to the Ratio, Attack and Release settings.

Ratio

The Ratio setting determines how hard the signal is compressed. (see illustration above).

Attack

The Attack time is the response time of the Compressor. The shorter Attack time the sooner the Compressor will reach the specified Ratio after the signal rises above the Threshold point.

Release

The Release time is the time it takes for the Compressor to release the gain reduction of the signal after the signal drops below the Threshold point again.

Peak Type

The TRIPLE•C is basically an RMS based Compressor, meaning that it responds to the average level of the incoming source material. This key turns the TRIPLE•C into a Peak based Compressor. When the key LED is lit the TRIPLE•C is in Peak mode. Peak mode is the general choice when processing percussive material. This feature is only available in Multi-band mode.

Softlim

Softlimiter on/off switch. Where the Compressor mostly is used to gradually reduce the dynamic content above the set Threshold point a limiter is used to directly avoid hitting an upper limit. Compressors and limiters are often used in conjunction. - The Compressor as the musical/gentle way of reducing the level and the limiter as a hard abrupt control to avoid distortion. See illustration.

Look Ahead

Press to activate the 3ms Look-ahead delay. This gives an even better and more precise compression performance of the TRIPLE•C. - 3ms is approx the time it takes for sound to travel 1 meter.

Spectral Adjust

Lo-Freq & Hi-Freq Controls

Applying the same Ratio, Attack and Release settings for both Lo, Mid and Hi bands will often result in an un-even Output frequency balance. With the Lo-Freq and Hi-Freq controls you can adjust the Output level of the Lo and Hi-Frequency bands.

MULTI-BAND MODE

Makeup Gain

Bypass

Press to bypass the TRIPLE•C. All processing parameters are bypassed. Input level control and all system settings found in the I/O menu are not bypassed.

Level

When a signal is compressed the max Output level of the signal is reduced. Since it is a reduction in dynamic content and not a gain-reduction that is the object of applying compression a make-up gain is necessary to lift the signal to appropriate level. Observe the gain reduction via the meters and lift the processed signal to approx. 0dB using the Level knob in the Make Up Gain section.

For detailed information please read the section on make up gain in the section called "Using Compression".

Edit Menu

To enter the Edit menu.

- Press MENU.
- Use the VALUE SET wheel to select the Edit menu and press ENTER.

Comp Style

Various predefined Compression Styles can be selected. Evaluate the Source material and choose appropriate style.

DRG - Digital Radiance Generator

Range: 0 -10

With this parameter you can add second harmonic distortion. This is a commonly used tube-simulation that will add warmth to the signal.

Hi X-Over

Range: 20Hz to 20kHz

Sets the Hi Frequency Cross-over point.

Lo X-Over

Range: 20Hz to 20kHz

Sets the Lo Frequency Cross-over point.

Cross-over Freq - illustration.

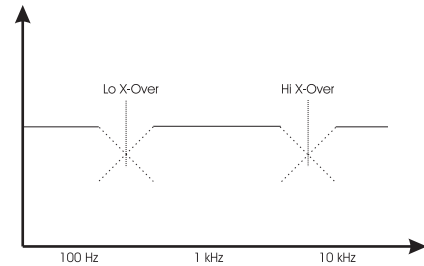

External Sidechain

Range: Off, On, Add

Determines how the TRIPLE•C should respond to the signal present on the External Sidechain.

- Off : This is the "Normal" setting. The TRIPLE•C will only respond to the Input signal and not to any signal present on the Sidechain.
- On : The compression will be controlled only by the signal present on the Sidechain Input.
- Add : In this mode the TRIPLE•C will respond both to the Input signal and to the signal present on the Sidechain. The Input signal and the Sidechain signal are added for compression control. Please note that the signal present on the Sidechain Input under no circumstances is passed to the Outputs. The Sidechain Input is only for compression control.

Meters

In Multi-band mode the meters indicates the applied compression in both the Lo, Mid, and Hi bands.

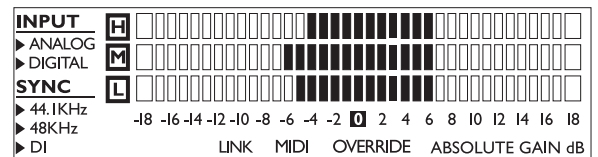

ENVELOPE MODE

Envelope mode is a special feature of the TRIPLE•C that lets you control the entire compression process in detail allowing full control from the point where the Compressor starts modifying the signal until it releases its grip again.

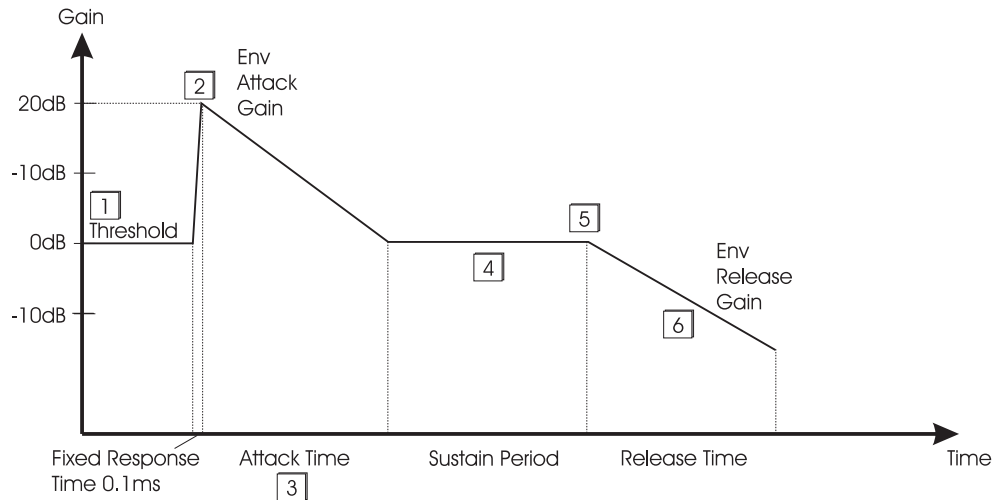

To select the Envelope mode

- Press the ENVELOPE MODE key in the Spectral Adjust section.

Input Section

Input Level

Adjusts the Input level of the TRIPLE•C. Play your source material through the TRIPLE•C and observe the Input meters in the display. Correct operation level is approx -6 to -3dBs with an occasional peak at 0dB. If the the Input signal at any time overloads, - reduce the Input level.

Dynamic Section

Threshold (1)

When the signal is above the set Threshold point the Compressor is activated and the gain of any signal above the Threshold point is processed according to the Attack and Release settings.

Envelope Attack Gain (2)

This is the level the signal will be boosted/attenuated to in 0.1ms (fixed response time) when the signal exceeds the Threshold.

Attack (3)

The Attack time is the time it takes for the Compressor to reach Threshold level again.

Sustain Period (4)

This is not an adjustable parameter. The signal is sustained at the Threshold level until the Input signal drops below the Threshold point (5).

Release (6)

The Release time Defines the time the Compressor continues to process the signal after the Input signal has dropped below Threshold.

Envelope Release Gain

This is the gain applied to the signal after the signal has dropped below the Threshold point. This can be used e.g. to manipulate the sustain of the signal.

Peak Type

Peak Type is not available in the Envelope mode.

ENVELOPE MODE

Softlim

Softlimiter on/off switch. Where a Compressor mostly is used to gradually reduce the dynamic content above the set Threshold point a limiter is used to directly avoid hitting an upper limit. Compressors and limiters are often used in conjunction. - The Compressor as the musical/gentle way of reducing the level and the Limiter as a hard abrupt control to avoid distortion. See illustration.

Makeup Gain

Bypass

Press to bypass the TRIPLE•C. All processing parameters are bypassed. Input Level control and all System settings found in the I/O menu are not bypassed.

Level

When a signal is compressed the max Output level of the signal is reduced. Since it is a reduction in dynamic content and not a gain-reduction that is the object of applying compression a make-up gain is necessary to lift the signal to appropriate level. Observe the gain reduction via the meters and lift the processed signal to approx. 0dB using the Level knob in the Make Up Gain section. For detailed information please read the section on make up gain in the section called "Using Compression".

Edit Menu

To enter the Edit menu

- Press **MENU**.
- Use the **VALUE SET** wheel to select the Edit menu and press **ENTER**.

DRG - Digital Radiance Generator

Range: 1-10

With this parameter you can add second harmonic distortion. This is a commonly used tube-simulation that will add warmth to the signal.

External Sidechain

Range: Off, On, Add

Determines whether the TRIPLE•C should respond to the signal present on the External Sidechain.

- Off : This is the "Normal" setting. The TRIPLE•C will only respond to the Input signal and not to any signal present on the Sidechain.
- On : The compression will be controlled only by the signal present on the Sidechain Input.
- Add : In this mode the TRIPLE•C will respond both to the Input signal and to the signal present on the Sidechain. The Input signal and the Sidechain signal are added for compression control. Please note that the signal present on the Sidechain Input under no circumstances is passed to the Outputs. The Sidechain Input is only for compression control.



Hi X-Over, Lo X-Over and Comp Style are ineffective in the Envelope mode.

SIDECCHAIN OPERATION

The TRIPLE•C can be set up to use an external source as Sidechain Input to either control or contribute to the compression of the source material. The Sidechain modes allows the TRIPLE•C to react on either:

- The Sidechain Input only. (ON - mode)
- A mix between the original Input and the Input present on the Sidechain. (ADD - mode)

To select the Sidechain mode:

- Press MENU.
- Select the “Edit menu” using the VALUE SET wheel and press ENTER.
- Use the PARAMETER wheel to select “Ext Side” and the VALUE SET wheel to select Sidechain mode.

Ext. Sidechain set to “ON”

Over-rites the original source and takes full control of the responds of the Compressor. This can be used in various applications e.g. for inputting a spectrally shaped version of the original source, and thereby force the Compressor to respond to a certain frequency area.

Ext. Sidechain set to “ADD”

Mixes the signal present on the external Sidechain In with the original source material present on the Main Input.

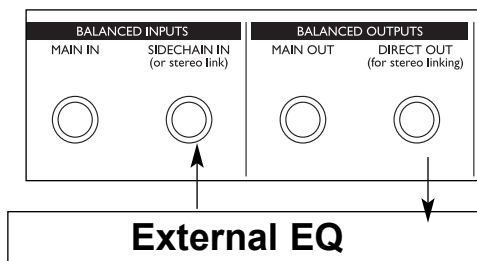

TRIPLE•C Stereo Channel

When using the TRIPLE•C Stereo Channel version as a Single Channel Compressor with Sidechain use:

- Left Input and left Output for source material processing.
- Right Input for Sidechain Input.
- Right Output for Direct Out.

Stereo Link

Stereo Setup

It is possible to use two TRIPLE•C Single Channel units as one stereo compressor where all parameters are linked.

To achieve this:

- Connect Direct Out of the “Master” TRIPLE•C to the Sidechain In of the “Slave” TRIPLE•C and vice versa (see illustration below).
- Connect MIDI Out from the “Master” to MIDI In on the “Slave”.
- Go to the I/O menu on both units and select Link “On”. The “Master” TRIPLE•C is now controlling all parameters of the “Slave” TRIPLE•C. With this setup the two units will operate as one stereo Compressor. Both units/channels will respond and compress the source material according to the signal present on both Input channels.

Dual Mono Setup

To use two TRIPLE•C units in a dual-mono setup, no Sidechain connections should be made - only MIDI Out from the “Master” unit to MIDI In on the “Slave” unit. Select Link “On” in the I/O menu on both units and all parameters on the “Master” unit are now automatically copied to the “Slave” unit. The two units will respond only to their own Input.

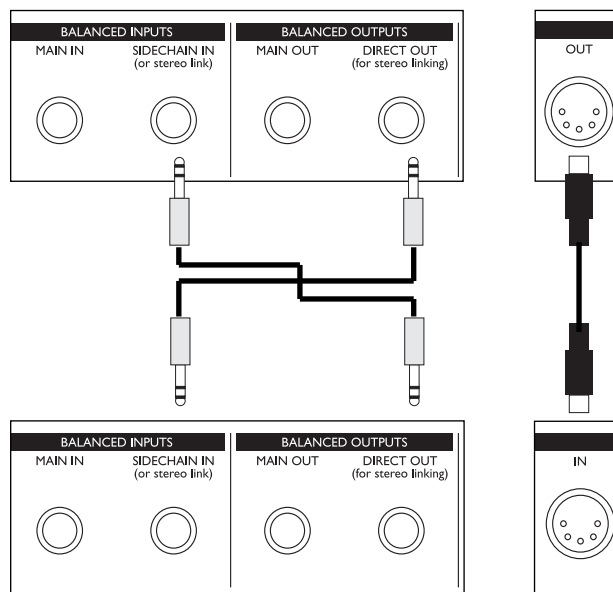

USING COMPRESSION - INTRODUCTION

Compression in general

If you are an experienced user of audio Compressors you may want to skip this section, which is a general explanation of what Compressors do and how they are applied in audio production.

Compression is generally used to reduce the dynamic content of an audio signal. Now, why is this necessary? Compared to the human ear any electronic reproduction of audio is limited by the available technology. Whereas the human ear has an incredible flexibility/dynamic range, letting you hear a pin dropping one moment, and an airplane taking off the moment after, - various physical limitations of the electronic components makes this type of flexibility impossible to achieve in audio reproduction.

Electronic reproduction of sound has two limitations. In the low end, the signal level must be well above the base noise, also referred to as the "noisefloor" introduced by the electronic components. The upper limit is determined by the internal operating voltages. If exceeded, distortion will be the result. As a certain amount of headroom needs to be reserved for peaks in the audio material even less dynamic range is available. So, on one hand you would like to have as much headroom as possible, but at the same time avoid having the average level too close to the noise floor. This is where compression is applied. With the Compressor you control/reduce the peaks in the audio signal and the average level of the audio signal can be increased.

The first type of Compressors (in the 1930's) were very simple constructions with two controllable parameters. With one of the two controls the user had to find a setting based upon an presumed average audio level of the material about to be processed. The other control (Ratio) specified the reduction of dynamic content in the entire signal that passed through the unit. This way the signal was compressed from both sides, low levels were increased by the same amount as the high levels were decreased.

Modern Compressors uses a Threshold point. When the signal increases above the specified Threshold point the Compressor begins to reduce the Output signal by an amount set by the Ratio parameter. Once the signal drops below the Threshold point the Compressor stops interfering.

Compressors vs Limiters

Where the Compressor mostly is used to gradually reduce the dynamic content above the set Threshold point a limiter is used to directly avoid hitting an upper limit. Compressors and limiters are often used in conjunction. - The Compressor as the musical/gentle way of reducing the level and the limiter as a hard abrupt control to avoid distortion/clipping.

Multi-band Compression

With multi-band Compressors such as the TRIPLE•C you are able to differentiate the compression on different frequency areas in the audio signal. The audio signal is split in to several frequency areas and you can obtain considerably better results when working with a complex signal with a wide frequency area. When working with a non-multi-band Compressor on e.g. a bass drum will invoke the Compressor to reduce the dynamic content of the entire signal when activated. This gives what it often referred to as the "pumping/breathing" effect. By splitting up the signal in to e.g. 3 bands; low, mid and high and use different Threshold/Ratio settings on these bands a much better result can be achieved.

However, there are times to use multi-band compression and times to use traditional full-range compression. The TRIPLE•C gives you both.

USING COMPRESSION

Though you can say that using a Compressor in general is about reducing the dynamic content of a signal thereby having better control, there are many different angles on how to use compression. Depending on the specific application you may have different starting points and goals when you apply compression. As personal style also is a major consideration it is hard to give specific answers on how to use compression. However, here are some guidelines.

First a short description of the basic parameters.

Illustration

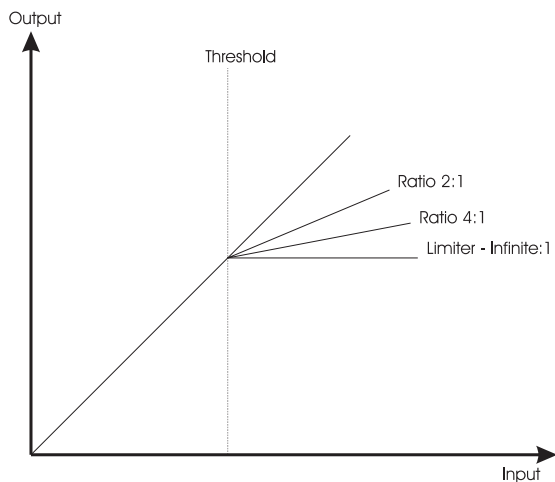

Dynamic Section

Threshold

When the signal rises above the set Threshold point the Compressor is activated.

Ratio

The Ratio setting determines how hard the signal is compressed.

Attack

The Attack time is the response time of the Compressor. The shorter Attack time the sooner the Compressor will start to work after the signal rises above the set Threshold.

Release

The Release time is the time it takes for the Compressor to release the gain reduction of the signal after the signal drops below the Threshold point again.

Example:

Threshold is set to -6dB

Ratio is set to 2:1

Attack is set to 10ms

Release is set to 300ms

A relatively loud musical phrase reaches -2dB on the Input. As the Threshold is set to -6dB, 4dB of the signal will be processed. The Ratio of 2:1 means that each of the 4dBs above Threshold will be reduced to 0.5dB. So, the 4dB above Threshold on the Input side will be reduced to only 2dB on the Output. This gain-reduction is reached in 10ms which is specified by the Attack time. When the Input signal drops below the Threshold (-6dB) again, the Compressor ceases to process/reduce the Output signal. The Release time specifies how long it will take until no processing is taking place.

Spectral Adjust Section

Selecting Full-range or Multi-band mode

Evaluate the frequency range of the source material. If your source material has a wide frequency range with peaks in specific frequency areas, the Multi-band mode should probably be your choice. If on the other hand you are working on e.g a repeating back-up vocal harmony within a relatively small frequency area the Full range mode would apply perfectly.

Better Definition of Vocal material

If the object is to define the Source material e.g a voice a gentle compression would be appropriate. By delicately controlling the peaks of the signal you are able increase the overall level of the signal and the low level content of the signal will be increased. Try using a high Threshold setting to keep the dynamic content of the signal and to avoid processing the entire signal all the time. A low to medium Ratio and Attack setting will give you the soft and often desired compression used when working with vocals.

Guideline Settings

Ratio: 2:1

Attack: 10ms

Release: 200ms

USING COMPRESSION

Hard Compression of Vocal Tracks.

By compressing vocal source material hard a very distinct and precise but less dynamic track will be the result. For this purpose we need the Compressor to work practically all the time. Therefore the Threshold must be set rather low, the Ratio rather high and the Attack time short. The release time setting again depends on what it is you would like to achieve. If you wish with this “hard compression scenario” to hear e.g. the singer taking the next breath in between his/hers actual singing a short Release time should be your choice. A long release time on the other hand would compensate for this

Guideline Settings

Ratio: 5-6:1

Attack: 5ms

Release: 100ms

Controlling Percussive Material

When using compression on e.g. a snare drum entirely different aspects are to be taken in consideration compared to vocal processing. A drum has a sharp attack but almost no duration. For the Compressor to take effect at all a really short Attack time is essential. The Threshold can be set relatively low as you probably want to process all snare-drum hits. The Ratio setting for this application is really where you can add different characteristics on the signal. The higher a Ratio setting the more flat but distinct a sound you can create. Too high a Ratio setting allows only a small amount of the source materials original characteristics to be maintained.

Guideline Settings

Ratio: 4:1

Attack: 1.0 ms

Release: 100ms

Makeup Gain

When a signal is compressed the max Output level of the signal is reduced. Since it is a reduction in dynamic content and not a gain-reduction that is the object of applying compression a make-up gain is necessary to lift the signal to appropriate level.

Also when using the bypass function for comparing the unprocessed signal with the processed signal equal level for these modes is essential.

The meters on the TRIPLE•C are excellent tools to achieve this. Let's have a closer look at the meters.

When no signal passes through the unit the gain is illustrated like this:

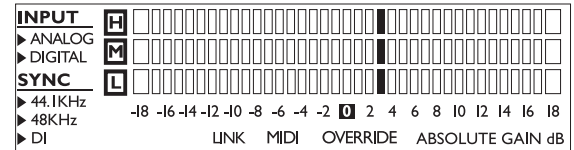

Try turning the Make-up Level knob to change the level. If no compression is applied you are now actually changing the Output level.

When the signal is processed/compressed the Output level is reduced. The amount of gain reduction/compression applied is illustrated via the via the meters like this: (example in Multi-band mode)

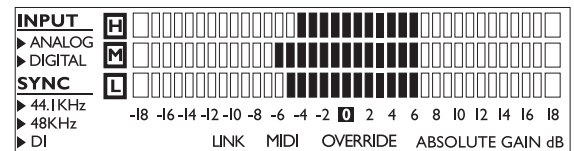

To achieve the same Output level on the processed signal as on the unprocessed signal simply turn up the Makeup Gain level knob until the max gain reduction is at the 0dB marker.

This will look approximately like this :

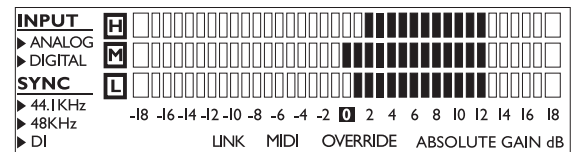

This is how easy it is to apply Make-up gain using the TRIPLE•C.

IMPORTANT SAFETY INSTRUCTIONS

Please read, keep, and follow these instructions before connecting this unit. Heed all warnings and instructions. Retain this notice and the owner's manual for future reference.



The lightning flash with an arrowhead symbol within an equilateral triangle, is intended to alert the user to the presence of uninsulated "dangerous voltage" within the product's enclosure that may be of sufficient magnitude to constitute a risk of electric shock to persons.



The exclamation point within an equilateral triangle is intended to alert the user to the presence of important operating and maintenance (servicing) instructions in the literature accompanying the product.

Warning!

- To reduce the risk of fire or electric shock, do not expose this unit to rain or moisture.
- Do not open the unit - risk of electric shock inside.
- This apparatus must be earthed.
- Use a three wire grounding type line chord like the one supplied with the product.
- Be advised that different operating voltages require the use of different types of line cord and attachment plugs. If in doubt please contact your TC distributor.
- Check the voltage in your area and use the correct type. See table below:

Voltage	Line plug according to standard.
110-125V	UL817 and CSA C22.2 no 42.
220-230V	CEE 7 page VII, SR section 107-2-D1/IEC 83 page C4.
240V	BS 1363 of 1984. Specification for 13A fused plugs and switched and un-switched socket outlets.

- Mount in a well ventilated rack with a little space above and below.
- This equipment should be installed near the socket outlet and disconnection of the device should be easily accessible.
- Do not install near heat source, such as radiators, heat registers, stoves or other apparatus. (including amplifiers) that produce heat.
- Do not rely solely on the front screws when mounted in touring rack. Support the back as well.
- Clean only with a damp cloth.
- Do not defeat the safety purpose of a polarized or grounding type plug. A polarized plug has two blades with one wider than the other. A grounding type plug has two blades/prongs and a third grounding prong. The wide blade or the third prong are provided for your safety. When the provided plug does not fit into your outlet, consult an electrician for replacement of the obsolete outlet.
- Protect the power cord from being walked on or pinched particularly at plugs convenience receptacles, and the point where they exit from the apparatus.
- Only use attachments/accessories specified by the manufacturer.
- Unplug this apparatus during lightning storms or when unused for long periods of time.

IMPORTANT SAFETY INSTRUCTIONS

Service

There are no user-serviceable parts inside. All service must be performed by qualified personnel. Servicing is required when:

- the unit has been damaged in any way, such as when the power-supply cord or plug is damaged.
- the unit has been exposed to rain or moisture, or liquid has been spilled into the unit.
- objects have fallen into the unit.
- the unit does not work properly.
- the unit has been dropped.

This equipment has been tested and found to comply with the limits for a Class B Digital device, pursuant to part 15 of the FCC rules.

These limits are designed to provide reasonable protection against harmful interference in a residential installations.

This equipment generates, uses and can radiate radio frequency energy and, if not installed and used in accordance with the instructions, may cause harmful interference to radio communications. However, there is no guarantee that interference will not occur in a particular installation.

If this equipment does cause harmful interference to radio or television reception, which can be determined by turning the equipment off and on, the user is encouraged to try to correct the interference by one or more of the following measures:

- Reorient or relocate the receiving antenna.
- Increase the separation between the equipment and receiver.
- Connect the equipment into an outlet on a circuit different from that to which the receiver is connected.
- Consult the dealer or an experienced radio/TV technician for help.

The user may find the following booklet, prepared by the Federal Communications Commission, helpful:
"How to identify and Resolve Radio/TV interference Problems."

This booklet is available from the US. Government Printing Office, Washington, DC 20402, Stock No. 004-000-0034-4.

Caution:

You are cautioned that any change or modifications not expressly approved in this manual could void your authority to operate this equipment.

For the customers in Canada:

This Class B Digital apparatus meets all requirements of the Canadian Interference-Causing Equipment Regulations. Cet appareil numérique de la classe B respecte toutes les exigences du Règlement sur le matériel brouilleur du Canada.

Certificate Of Conformity

TC Electronic A/S, Sindalsvej 34, 8240 Risskov, Denmark, hereby declares on own responsibility that following product:

TRIPLE•C MULTI-BAND COMPRESSOR & ENVELOPE

- that is covered by this certificate and marked with CE-label conforms with following standards:

EN 60065 (IEC 60065)	Safety requirements for mains operated electronic and related apparatus for household and similar general use
EN 55103-1	Product family standard for audio, video, audio-visual and entertainment lighting control apparatus for professional use. Part 1: Emission.
EN 55103-2	Product family standard for audio, video, audio-visual and entertainment lighting control apparatus for professional use. Part 2: Immunity.

With reference to regulations in following directives:
73/23/EEC, 89/336/EEC

Issued in Risskov, September 2000

Anders Fauerskov
Chief Executive Officer

APPENDIX - MIDI IMPLEMENTATION CHART

MULTI-BAND COMPRESSOR & ENVELOPE SINGLE CHANNEL/STEREO CHANNEL VERSION

Function		Transmitted	Recognized
Basic Channel	Default	1	1
	Changed	1-16	1-16
Mode	Default		
	Messages	X	X
	Altered		
Note Number		X	X
	True Voice	X	X
Velocity	Note ON	X	X
	Note OFF	X	X
After Touch	Key's	X	X
	Ch's	X	X
Pitch Bend		X	X
Control Change		X O	X O
Prog Change		O	O
System Excl. Common		O	O
	Song Pos	X	X
	Song Sel	X	X
	Tune	X	X
System real time	Clock	X	X
	Commands	X	X
Aux Messages	Local ON/OFF	X	X
	All Notes OFF	X	X
	Active Sense	X	X
	Reset	X	X
Clock		Not recognized	

O: YES
X: NO

Mode 1: OMNI ON, POLY
Mode 3: OMNI OFF, POLY

Mode 2: OMNI ON, MONO
Mode 4: OMNI OFF, MONO

APPENDIX - MIDI CONTROL CHANGES

Using any standard MIDI device to transmit Continuous Controllers you are able to control various parameters in the TRIPLE-C. Please refer to the manual of the sending device on how to set up the Controller numbers.

Parameter Names	MIDI CC
In Level	16
Out Level	17
Digital In Gain	18
Bypass	20
Threshold	48
Ratio	49
Attack	50
release	51
L-Freq Level	52
Hi-Freq Level	53
Level	54
Style	55
DRG	56
Hi X-Over	57
Lo X-Over	58
Ext. Sidechain	59
Multi-band	60
Peak Type	61
Soft Limiter	62
Look Ahead Delay	63
Envelope	64

APPENDIX - TECHNICAL SPECIFICATIONS

Digital Inputs and Outputs

Connectors:	RCA Phono (S/PDIF)
Formats:	S/PDIF (24 bit), EIAJ CP-340, IEC 958
Output Dither:	HPF/TPDF dither 24/20/16/8 bit
Sample Rates:	44.1 kHz, 48 kHz
Processing Delay:	0.1 ms @ 48 kHz (excl. optional look-ahead delay)
Frequency Response DIO:	DC to 23.9 kHz \pm 0.01 dB @ 48 kHz

Analog Inputs

Connectors:	1/4" phone jack, balanced
Impedance, Bal / Unbal:	21 kOhm / 13 kOhm
Max. Input Level:	+24 dBu
Min. Input Level for 0 dBFS:	0 dBu
Sensitivity:	@ 12 dB headroom: -12 dBu to +12 dBu
A to D Conversion:	24 bit, 128 x oversampling bitstream
A to D Delay:	0.65 ms / 0.70 ms @ 48 kHz / 44.1 kHz
Dynamic Range:	100 dB typ, 20 Hz - 20 kHz
THD:	typ < 92 dB (0,0025 %) @ 1 kHz
Frequency Response:	+0/-0.1 dB @ 48 kHz, 20 Hz to 20 kHz
Crosstalk:	<-95 dB, 20 Hz to 20 kHz

Analog Outputs

Connectors:	1/4" phone jack, balanced
Impedance Balanced/ Unbalanced:	40 Ohm
Max. Output Level:	+20 dBu (balanced)
Output Ranges:	Balanced: 20/14/8/2 dBu Unbalanced: 14/8/2 dBu
D to A Conversion:	24 bit, 128 x oversampling bitstream
D to A Delay:	0.63 ms / 0.68 ms @ 48 kHz / 44.1 kHz
Dynamic Range:	104 dB typ, 20 Hz to 20 kHz
THD:	typ <-94 dB (0.002 %) @ 1 kHz, +20 dBu Output
Frequency Response:	+0/-0.5 dB @ 48 kHz, 20 Hz to 20 kHz
Crosstalk:	<-100 dB, 20 Hz to 20 kHz

EMC

Complies with:	EN 55103-1 and EN 55103-2 FCC part 15, Class B, CISPR 22, Class B
----------------	--

Safety

Certified to:	IEC 65, EN 60065, UL6500 and CSA E65
---------------	--------------------------------------

Environment

Operating Temperature:	32° F to 122° F (0° C to 50° C)
Storage Temperature:	-22° F to 167° F (-30° C to 70° C)
Humidity:	Max. 90 % non-condensing

Control Interface

MIDI:	In/Out/Thru: 5 Pin DIN
Pedal:	1/4" phone jack

General

Finish:	Anodized aluminum front Plated and painted steel chassis
Display	23 character / 280 icon STN-LCD display
Dimensions:	19" x 1.75" x 8.2" (483 x 44 x 195 mm)
Weight:	4.1 lb. (1.85 kg)
Mains Voltage:	100 to 240 VAC, 50 to 60 Hz (auto-select)
Power Consumption:	<15 W
Warranty Parts and labor:	1 year

Technical Specifications are subject to change without notice !

PRESET LIST

The Tripple•C holds 50 factory presets. The preset names and locations are listed below. In addition you can store up to 100 of your own presets in the User bank.

- | | | | |
|----|------------------|----|------------------|
| 1 | Triple-C Comp | 26 | Background Voc's |
| 2 | Light Female Voc | 27 | BG's Heavy Comp |
| 3 | Medium Female | 28 | Light Speak Comp |
| 4 | Heavy Female Voc | 29 | Tube Speak Comp |
| 5 | Light Male Voc | 30 | Tube Vocal Comp |
| 6 | Medium Male Voc | 31 | FB Vocal Comp |
| 7 | Heavy Male Voc | 32 | FB Subtle Comp |
| 8 | De-Essed Female | 33 | FB Vintage Comp |
| 9 | De-Essed Male | 34 | FB Breath Comp |
| 10 | Subtle Vocal Com | 35 | FB Rapin' Comp |
| 11 | Bright Vocal | 36 | FB Speak Comp |
| 12 | Bass Compressor | 37 | FB Bass Comp |
| 13 | Tube Bass Comp | 38 | FB Funky GTR |
| 14 | Fast Bass Comp | 39 | FB Snare Comp |
| 15 | Light GTR Comp | 40 | FB Drum Comp |
| 16 | Rhythm GTR Comp | 41 | ENV Snappy Snare |
| 17 | Natural GTR Comp | 42 | ENV No Attack |
| 18 | Snare Comp | 43 | ENV Short Gated |
| 19 | Bright Snare | 44 | ENV Sustainer |
| 20 | Bassdrum Comp | 45 | ENV Inverse SN |
| 21 | Slow BD Comp | 46 | ENV Broken Comp |
| 22 | Drumkit Comp | 47 | ENV Click Kick |
| 23 | Heavy Drum Comp | 48 | ENV Slapback SN |
| 24 | Saxophone Comp | 49 | ENV Slap & Snap |
| 25 | Horns Hit Me !! | 50 | Break That Beat |